



PEL-5000C Series

Compact High Power D.C. Electronic Load

FEATURES

- Maximum Power up to 192KW
- Maximum up to 8 units Master/Slave Parallel Control
- 5 digit V/A/W Meter
- High-speed Measurement and Communication Transmission
- Large LCD Display, Setting Values Can be Adjusted by Rotary Knob or Push Button
- Voltage \setminus Current and Watt Value Can be Displayed Simultaneously
- Capable for Power Factor Correction (PFC) Test (for 600V,1200V Models)
- OCP, OPP Test Function Automatically
- Power ON Status Can be Set
- CC, CR, CV, CP, Dynamic and Short Operation Mode
- SHORT Time Setting
- Protections Against I,W, $^{\circ}$ C and Over-voltage Alert
- Voltage Meter Display the Polarity Positive”+”or Negative”-” is Selectable
- Optional Interface : GPIB, RS232, USB, LAN

GW INSTEK
Simply Reliable

Compact High Power DC Electronic Load



PEL-5000C Series



DESCRIPTIONS

- PEL-5000C Series has its own control and display panel, CC/CR/CV/CP/Dynamic modes, 150 sets Store/Recall memory which provides load set-up more efficiently, also can be remote controlled via GPIB \ RS232 USB and LAN interface.
- SHORT time setting and SHORT_VH, SHORT_VL setting function, also can measure Short Voltage and Current.
- Dynamic can be simulated under CC, CP mode. The current Rise/Fall slew rate can be adjusted individually and there is an external signal input for a Arbitrary Waveform to simulate load current.
- Single key for OCP \ OPP test function will be more efficiency and accuracy on OCP \ OPP testing.
- Programmable Load ON/OFF voltage, GO/NG meter check, Voltage meter display " + " or " - " is selectable and 150 sets Store/Recall larger memory is much advance feature for each different application.
- 150 sets test parameter and status storage function, user can recall the storage memory real time in accordance with the auto sequence requirement.
- Maximum Voltage up to 1200V provide an idea testing solution for Power Factor Correction test.
- Master/Slave control units maximum are up to 1 MASTER, 7 SLAVES.

APPLICATIONS

- Voltage/Current Source
- SMPS Transient Response
- CV/Current Limit Testing and Battery Emulation
- Battery Charger
- Battery Discharge
- R&D Quality Control
- ATE System
- Production Testing

Compact High Power DC Electronic Load

SPECIFICATIONS								
MODEL	PEL-5006C-150-600		PEL-5008C-150-800		PEL-5010C-150-1000		PEL-5012C-150-1200	
Power ^{*1}	6KW		8KW		10KW		12KW	
Current	0 ~ 60A	0 ~ 600A	0 ~ 80A	0 ~ 800A	0 ~ 100A	0 ~ 1000A	0 ~ 120A	0 ~ 1200A
Voltage	0 ~ 150V							
Min. Operating Voltage	0.7V @ 600A		0.7V @ 800A		0.7V @ 1000A		0.7V @ 1200A	
Protections								
Over Power Protection (OPP)	105%							
Over Current Protection (OCP)	104%							
Over Voltage Protection (OVP)	105%							
Over Temp Protection (OTP)	90°C±5°C							
Constant Current Mode								
Range ^{*2}	60A	600A	80A	800A	100A	1000A	120A	1200A
Resolution	0.96mA	9.6mA	1.28mA	12.8mA	1.6mA	16mA	1.92mA	19.2mA
Accuracy ^{*3}	± 0.05% of (Setting + Range)							
Constant Resistance Mode								
Range	15000Ω-0.25Ω	0.25Ω-0.0012Ω	11250Ω-0.1875Ω	0.1875Ω-0.0009Ω	9000Ω-0.15Ω	0.15Ω-0.0007Ω	7500Ω-0.125Ω	0.125Ω-0.0006Ω
Resolution	66.666μS	4.167μΩ	88.888μS	3.125μΩ	111.111μS	2.5μΩ	133.333μS	2.084μΩ
Accuracy	± 0.2% of (Setting + Range)							
Constant Voltage Mode								
Range	150V							
Resolution	2.5mV							
Accuracy	± 0.05% of (Setting + Range)							
Constant Power Mode								
Range	600W	6000W	800W	8000W	1000W	10000W	1200W	12000W
Resolution	9.6mW	96mW	12.8mW	128mW	16mW	160mW	19.2mW	192mW
Accuracy	± 0.1% of (Setting+Range)	± 0.1% of (Setting+Range)	± 0.1% of (Setting+Range)	± 0.1% of (Setting+Range)	± 0.1% of (Setting+Range)	± 0.1% of (Setting+Range)	± 0.1% of (Setting+Range)	± 0.1% of (Setting+Range)
Constant Voltage Mode + Constant Current Mode								
Range	150V	600A	150V	800A	150V	1000A	150V	1200A
Resolution	2.5mV	9.6mA	2.5mV	12.8mA	2.5mV	3.2mA	2.5mV	19.2mA
Accuracy	± 1.0% of (Setting + Range)							
Constant Voltage Mode + Constant Power Mode								
Range	150V	6000W	150V	8000W	150V	10000W	150V	12000W
Resolution	2.5mV	96mW	2.5mV	128mW	2.5mV	160mW	2.5mV	192mW
Accuracy	± 1.0% of (Setting + Range)							
Surge Test								
Surge & Normal current	0-600A		0-800A		0-1000A		0-1200A	
Surge time	10-1000ms		10-1000ms		10-1000ms		10-1000ms	
Surge step	1-5							
MPPT Mode								
Algorithm	P&O							
Load mode	CV							
P&O interval	1000ms-6000ms; resolution 1000ms							
Dynamic Mode								
Timing								
Thigh & Tlow	0.010-9.999 / 99.99 / 999.9 / 9999mS							
Resolution	0.001 / 0.01 / 0.1 / 1ms							
Accuracy	1μs / 10μs / 100μs / 1ms + 50ppm							
Slew Rate	0.0144A-0.9A/μs	0.144A-9A/μs	0.0192A-1.2A/μs	0.192A-12A/μs	0.024A-1.5A/μs	0.24A-15A/μs	0.0288A-1.8A/μs	0.288A-18A/μs
Resolution	0.0036A/μs	0.036A/μs	0.0048A/μs	0.048A/μs	0.006A/μs	0.06A/μs	0.0072A/μs	0.072A/μs
Min. Rise Time	66.7μs(typical)							
Current								
Range	0-60A	60-600A	0-80A	80-800A	0-100A	100-1000A	0-120A	120-1200A
Resolution	0.96mA	9.6mA	1.28mA	12.8mA	1.6mA	16mA	1.92mA	19.2mA
Measurement								
Voltage Read Back								
Range (5 Digital)	0-15V	15-150V	0-15V	15-150V	0-15V	15-150V	0-15V	15-150V
Resolution	0.25mV	2.5mV	0.25mV	2.5mV	0.25mV	2.5mV	0.25mV	2.5mV
Accuracy	± 0.025% of (Reading + Range)							
Current Read Back								
Range (5 Digital)	0-60A	60-600A	0-80A	80-800A	0-100A	100-1000A	0-120A	120-1200A
Resolution	0.96mA	9.6mA	1.28mA	12.8mA	1.6mA	16mA	1.92mA	19.2mA
Accuracy	± 0.05% of (Reading + Range)							
Power Read Back								
Range (5 Digital)	6000W		8000W		10000W		12000W	
Accuracy	± 0.06% of (Reading + Range)							
General								
Typical Short Resistance	0.0012Ω		0.0009Ω		0.0007Ω		0.0006Ω	
Maximum Short Current	600A		800A		1000A		1200A	
Load ON Voltage	0.25 - 62.5V							
Load OFF Voltage	0 - 62.5V							
Power Consumption	400VA		750VA		750VA		750VA	
Dimension (HxWxD)	446x444x763mm		572x444x763mm		572x444x763mm		572x444x763mm	
HxWxD (Not included wheels)	342x444x763mm		468x444x763mm		468x444x763mm		468x444x763mm	
Weight	62 kg		77.5 kg		84.8 kg		92 kg	
Temperature ^{*4}	0-40°C							
Safety & EMC	CE							

Cooling : Advanced Fan Cooled

Input AC Power : 100-240 Vac ±10% , 50/60Hz

Note *1 : The power rating specifications at ambient temperature = 25 °C

Note *2 : The range is automatically or forcing to range II only in CC Mode

Note *3 : If the operating current is below range 0.1%, the accuracy specification is 0.1% F.S.

Note *4 : Operating temperature range is 0-40°C , all specifications apply for 25°C±5°C

ORDER INFORMATION

Options: ① Hook ring ② Rack Mount Kit for Rack



x4



③ Handles ④ Remove wheels



PEL-5006C-150-600



150V , 600A , 6KW

PEL-5008C-150-800



150V , 800A , 8KW

PEL-5010C-150-1000



150V , 1000A , 10KW

PEL-5012C-150-1200



150V , 1200A , 12KW

Optional Interface: 1. GPIB Card 2. RS-232 Card 3. USB Card 4. LAN Card

Compact High Power DC Electronic Load

SPECIFICATIONS								
MODEL	PEL-5015C-150-1500		PEL-5018C-150-1800		PEL-5020C-150-2000		PEL-5024C-150-2000	
Power ^{*1}	15KW		18KW		20KW		24KW	
Current	0 – 150A	0 – 1500A	0 – 180A	0 – 1800A	0 – 200A	0 – 2000A	0 – 200A	0 – 2000A
Voltage	0 – 150V							
Min. Operating Voltage	0.7V @ 1500A		0.7V @ 1800A		0.7V @ 2000A		0.7V @ 2000A	
Protections								
Over Power Protection (OPP)	105%							
Over Current Protection (OCP)	104%							
Over Voltage Protection (OVP)	105%							
Over Temp Protection (OTP)	90°C±5°C							
Constant Current Mode								
Range ^{*2}	150A	1500A	180A	1800A	200A	2000A	200A	2000A
Resolution	2.4mA	24mA	2.88mA	28.8mA	3.2mA	32mA	3.2mA	32mA
Accuracy ^{*3}	± 0.05% of (Setting + Range)							
Constant Resistance Mode								
Range	6000Ω–0.1Ω	0.1Ω–0.0005Ω	5000Ω–0.0833Ω	0.0833Ω–0.0004Ω	4500Ω–0.075Ω	0.075Ω–0.0004Ω	4500Ω–0.075Ω	0.075Ω–0.0004Ω
Resolution	166.666μS	1.667μΩ	200μS	1.389μΩ	222.22μS	1.25μΩ	222.22μS	1.25μΩ
Accuracy	±0.2% of (Setting + Range)							
Constant Voltage Mode								
Range	150V							
Resolution	2.5mV							
Accuracy	± 0.05% of (Setting + Range)							
Constant Power Mode								
Range	1500W	15000W	1800W	18000W	2000W	20000W	2400W	24000W
Resolution	24mW	240mW	28.8mW	288mW	32mW	320mW	38.4mW	384mW
Accuracy	± 0.1% of (Setting+Range)	± 0.1% of (Setting+Range)	± 0.1% of (Setting+Range)	± 0.1% of (Setting+Range)	± 0.1% of (Setting+Range)	± 0.1% of (Setting+Range)	± 0.1% of (Setting+Range)	± 0.1% of (Setting+Range)
Constant Voltage Mode + Constant Current Mode								
Range	150V	1500A	150V	1800A	150V	2000A	150V	2000A
Resolution	2.5mV	24mA	2.5mV	28.8mA	2.5mV	32mA	2.5mV	32mA
Accuracy	± 1.0% of (Setting + Range)							
Constant Voltage Mode + Constant Power Mode								
Range	150V	15000W	150V	18000W	150V	20000W	150V	24000W
Resolution	2.5mV	240mW	2.5mV	288mW	2.5mV	320mW	2.5mV	384mW
Accuracy	± 1.0% of (Setting + Range)							
Surge Test								
Surge & Normal current	0–1500A		0–1800A		0–2000A		0–2000A	
Surge time	10–1000ms		10–1000ms		10–1000ms		10–1000ms	
Surge step	1–5							
MPPT Mode								
Algorithm	P&O							
Load mode	CV							
P&O interval	1000ms–60000ms ; resolution 1000ms							
Dynamic Mode								
Timing								
Thigh & Tlow	0.010–9.999 / 99.99 / 999.9 / 9999mS							
Resolution	0.001 / 0.01 / 0.1 / 1ms							
Accuracy	1μs / 10μs / 100μs / 1ms + 50ppm							
Slew Rate	0.036A–2.25A/μs	0.360A–22.5A/μs	0.0432A–2.7A/μs	0.432A–27A/μs	0.048A–3A/μs	0.48A–30A/μs	0.048A–3A/μs	0.48A–30A/μs
Resolution	0.009A/μs	0.09A/μs	0.0108A/μs	0.108A/μs	0.012A/μs	0.12A/μs	0.012A/μs	0.12A/μs
Min. Rise Time	66.7μs(typical)							
Current								
Range	0–150A	150–1500A	0–180A	180–1800A	0–200A	200–2000A	0–200A	200–2000A
Resolution	2.4mA	24mA	2.88mA	28.8mA	3.2mA	32mA	3.2mA	32mA
Measurement								
Voltage Read Back								
Range (5 Digital)	0–15V	15–150V	0–15V	15–150V	0–15V	15–150V	0–15V	15–150V
Resolution	0.25mV	2.5mV	0.25mV	2.5mV	0.25mV	2.5mV	0.25mV	2.5mV
Accuracy	±0.025% of (Reading + Range)							
Current Read Back								
Range (5 Digital)	0–150A	15–1500A	0–180A	180–1800A	0–200A	200–2000A	0–200A	200–2000A
Resolution	2.4mA	24mA	2.88mA	28.8mA	3.2mA	32mA	3.2mA	32mA
Accuracy	± 0.05% of (Reading + Range)							
Power Read Back								
Range (5 Digital)	15000W		18000W		20000W		24000W	
Accuracy	± 0.06% of (Reading + Range)							
General								
Typical Short Resistance	0.0005Ω		0.0004Ω		0.0004Ω		0.0004Ω	
Maximum Short Current	1500A		1800A		2000A		2000A	
Load ON Voltage	0.25 – 62.5V							
Load OFF Voltage	0 – 62.5V							
Power Consumption	1100VA		1100VA		1450VA		1450VA	
Dimension (HxWxD)	761x444x763 mm		761x444x763 mm		887x444x763 mm		887x444x763 mm	
HxWxD (Not included wheels)	657x444x763 mm		657x444x763 mm		783x444x763 mm		783x444x763 mm	
Weight	116.5 kg		124 kg		140.5 kg		155 kg	
Temperature ^{*4}	0–40°C							
Safety & EMC	CE							

Cooling : Advanced Fan Cooled

Input AC Power : 100–240 Vac ±10% , 50/60Hz

Note *1 : The power rating specifications at ambient temperature = 25°C

Note *2 : The range is automatically or forcing to range II only in CC Mode

Note *3 : If the operating current is below range 0.1%, the accuracy specification is 0.1% F.S.

Note *4 : Operating temperature range is 0–40°C , all specifications apply for 25°C±5°C

ORDER INFORMATION

PEL-5015C-150-1500

PEL-5018C-150-1800

PEL-5020C-150-2000

PEL-5024C-150-2000

Options: ① Hook ring ② Rack Mount Kit for Rack



150V · 1500A · 15KW



150V · 1800A · 18KW



150V · 2000A · 20KW



150V · 2000A · 24KW



x4



Optional Interface: 1. GPIB Card 2. RS-232 Card 3. USB Card 4. LAN Card

Compact High Power DC Electronic Load

Power Curve

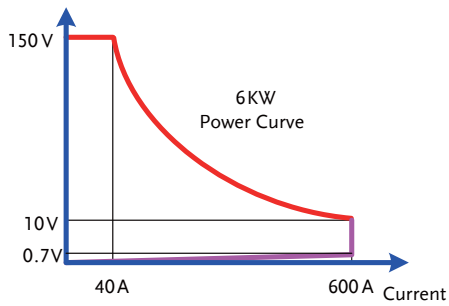

PEL-5006C-150-600

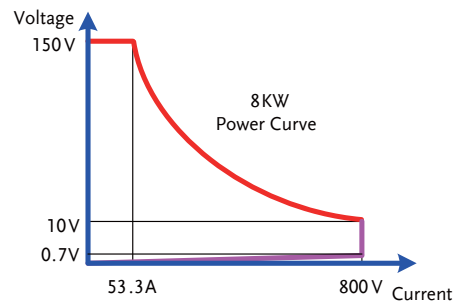

PEL-5008C-150-800

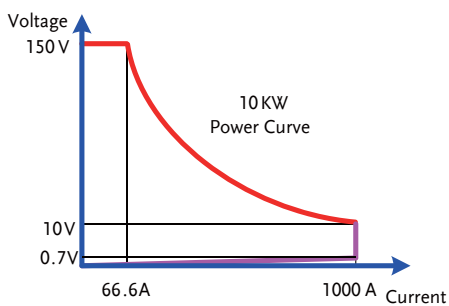

PEL-5010C-150-1000

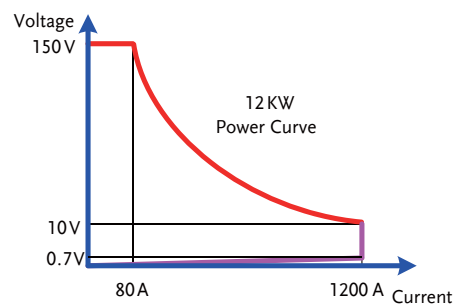

PEL-5012C-150-1200

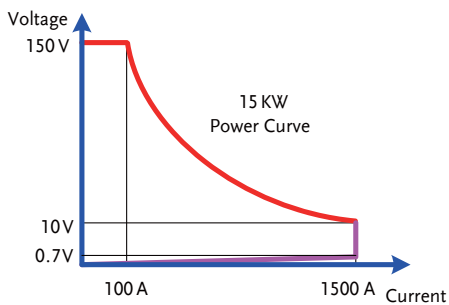

PEL-5015C-150-1500

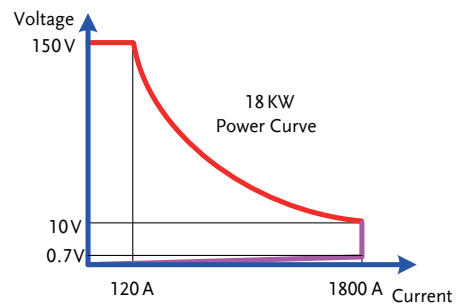

PEL-5018C-150-1800

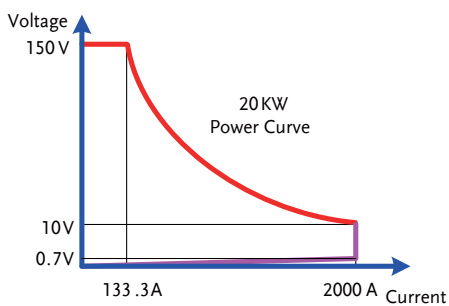

PEL-5020C-150-2000

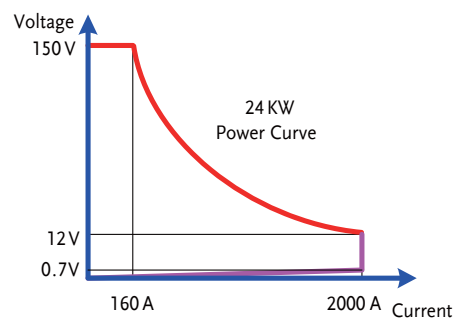

PEL-5024C-150-2000

Compact High Power DC Electronic Load

SPECIFICATIONS								
MODEL	PEL-5006C-600-420		PEL-5008C-600-560		PEL-5010C-600-700		PEL-5012C-600-840	
Power ^{*1}	6KW		8KW		10KW		12KW	
Current	0 ~ 42A	0 ~ 420A	0 ~ 56A	0 ~ 560A	0 ~ 70A	0 ~ 700A	0 ~ 84A	0 ~ 840A
Voltage	0 ~ 600V							
Min. Operating Voltage	10V @ 420A		10V @ 560A		10V @ 700A		10V @ 840A	
Protections								
Over Power Protection (OPP)	105%							
Over Current Protection (OCP)	104%							
Over Voltage Protection (OVP)	105%							
Over Temp Protection (OTP)	90°C±5°C							
Constant Current Mode								
Range ^{*2}	42A	420A	56A	560A	70A	700A	84A	840A
Resolution	0.672mA	6.72mA	0.896mA	8.96mA	1.12mA	11.2mA	1.334mA	13.44mA
Accuracy ^{*3}	± 0.05% of (Setting + Range)							
Constant Resistance Mode								
Range	85712Ω-1.42853Ω	1.42853Ω-0.02384Ω	64284Ω-1.0714Ω	1.0714Ω-0.01788Ω	51427.2Ω-0.85712Ω	0.85712Ω-0.014304Ω	42856Ω-0.714267Ω	0.714267Ω-0.01192Ω
Resolution	11.6669μS	23.84μΩ	15.5559μS	17.88μΩ	19.4449μS	14.304μΩ	23.3339μS	11.92μΩ
Accuracy	±0.2% of (Setting + Range)							
Constant Voltage Mode								
Range	600V							
Resolution	10mV							
Accuracy	± 0.05% of (Setting + Range)							
Constant Power Mode								
Range	600W	6000W	800W	8000W	1000W	10000W	1200W	12000W
Resolution	9.6mW	96mW	12.8mW	128mW	16mW	160mW	19.2mW	192mW
Accuracy	± 0.2% of (Setting+Range)	± 0.1% of (Setting+Range)	± 0.2% of (Setting+Range)	± 0.1% of (Setting+Range)	± 0.2% of (Setting+Range)	± 0.1% of (Setting+Range)	± 0.2% of (Setting+Range)	± 0.1% of (Setting+Range)
Constant Voltage Mode + Constant Current Mode								
Range	600V	420A	600V	560A	600V	700A	600V	840A
Resolution	10mV	6.72mA	10mV	8.96mA	10mV	11.2mA	10mV	13.44mA
Accuracy	± 1.0% of (Setting + Range)							
Constant Voltage Mode + Constant Power Mode								
Range	600V	6000W	600V	8000W	600V	10000W	600V	12000W
Resolution	10mV	96mW	10mV	128mW	10mV	160mW	10mV	192mW
Accuracy	± 1.0% of (Setting + Range)							
Surge Test								
Surge & Normal current	0-420A		0-560A		0-700A		0-840A	
Surge time	10-1000ms		10-1000ms		10-1000ms		10-1000ms	
Surge step	1-5							
MPPT Mode								
Algorithm	P&O							
Load mode	CV							
P&O interval	1000ms-6000ms ; resolution 1000ms							
Dynamic Mode								
Timing								
Thigh & Tlow	0.010-9.999 / 99.99 / 999.9 / 9999mS							
Resolution	0.001 / 0.01 / 0.1 / 1ms							
Accuracy	1μs / 10μs / 100μs / 1ms + 50ppm							
Slew Rate	0.0288-1.8A/μs	0.288A-18A/μs	0.0288A-1.8A/μs	0.288A-18A/μs	0.0336A-2.1A/μs	0.336A-21A/μs	0.0384A-2.4/μs	0.384A-24A/μs
Resolution	0.0072A/μs	0.072A/μs	0.0072A/μs	0.072A/μs	0.0084A/μs	0.084A/μs	0.0096A/μs	0.096A/μs
Current								
Range	0-42A	42-420A	0-56A	56-560A	0-70A	70-700A	0-84A	84-840A
Resolution	0.672mA	6.72mA	0.896mA	8.96mA	1.12mA	11.2mA	1.334mA	13.34mA
Measurement								
Voltage Read Back								
Range (5 Digital)	0-60V	60-600V	0-60V	60-600V	0-60V	60-600V	0-60V	60-600V
Resolution	1mV	10mV	1mV	10mV	1mV	10mV	1mV	10mV
Accuracy	±0.025% of (Reading + Range)							
Current Read Back								
Range (5 Digital)	0-42A	42-420A	0-56A	56-560A	0-70A	70-700A	0-84A	84-840A
Resolution	0.672mA	6.72mA	0.896mA	8.96mA	1.12mA	11.2mA	1.334mA	13.34mA
Accuracy	±0.05% of (Reading + Range)							
Power Read Back								
Range (5 Digital)	6000W		8000W		10000W		12000W	
Accuracy	± 0.06% of (Reading + Range)							
General								
Typical Short Resistance	0.0239Ω		0.0179Ω		0.0143Ω		0.00120Ω	
Maximum Short Current	420A		560A		700A		840A	
Load ON Voltage	0.4 ~ 100V							
Load OFF Voltage	0 ~ 100V							
Power Consumption	400VA		750VA		750VA		750VA	
Dimension (HxWxD)	446x444x763mm		572x444x763mm		572x444x763mm		572x444x763mm	
HxWxD (Not included wheels)	342x444x763mm		468x444x763mm		468x444x763mm		468x444x763mm	
Weight	62 kg		77.5 kg		84.8 kg		92 kg	
Temperature ^{*4}	0-40°C							
Safety & EMC	CE							

Cooling : Advanced Fan Cooled

Input AC Power : 100-240 Vac ±10% , 50/60Hz

Note *1 : The power rating specifications at ambient temperature = 25°C

Note *2 : The range is automatically or forcing to range II only in CC Mode

Note *3 : If the operating current is below range 0.1%, the accuracy specification is 0.1% F.S.

Note *4 : Operating temperature range is 0-40°C , all specifications apply for 25°C±5°C

ORDER INFORMATION

PEL-5006C-600-420



600V · 420A · 6KW

PEL-5008C-600-560



600V · 560A · 8KW

PEL-5010C-600-700



600V · 700A · 10KW

PEL-5012C-600-840



600V · 840A · 12KW

Options: ① Hook ring ② Rack Mount Kit for Rack



x4



③ Handles

④ Remove wheels



Optional Interface: 1. GPIB Card 2. RS-232 Card 3. USB Card 4. LAN Card

Compact High Power DC Electronic Load

SPECIFICATIONS									
MODEL	PEL-5015C-600-1050		PEL-5018C-600-1260		PEL-5020C-600-1400		PEL-5024C-600-1680		
Power ^{*1}	15KW		18KW		20KW		24KW		
Current	0 ~ 105A	0 ~ 1050A	0 ~ 126A	0 ~ 1260A	0 ~ 140A	0 ~ 1400A	0 ~ 168A	0 ~ 1680A	
Voltage	0 ~ 600V								
Min. Operating Voltage	10V @ 1050A		10V @ 1260A		10V @ 1400A		10V @ 1680A		
Protections									
Over Power Protection (OPP)	105%								
Over Current Protection (OCP)	104%								
Over Voltage Protection (OVP)	105%								
Over Temp Protection (OTP)	90°C±5°C								
Constant Current Mode									
Range ^{*2}	105A	1050A	126A	1260A	140A	1400A	168A	1680A	
Resolution	1.68mA	16.8mA	2.016mA	20.16mA	2.24mA	22.4mA	2.688mA	26.88mA	
Accuracy ^{*3}	± 0.05% of (Setting + Range)								
Constant Resistance Mode									
Range	34284.8~0.571413Ω	0.571413~0.009536Ω	28570.67~0.476178Ω	0.476178~0.007947Ω	25713.6~0.42856Ω	0.42856~0.007152Ω	21428~0.357133Ω	0.357133~0.00596Ω	
Resolution	29.1674μS	9.536μΩ	35.0009μS	7.947μΩ	38.8899μS	7.152μΩ	46.6679μS	5.96μΩ	
Accuracy	±0.2% of (Setting + Range)								
Constant Voltage Mode									
Range	600V								
Resolution	10mV								
Accuracy	± 0.05% of (Setting + Range)								
Constant Power Mode									
Range	1500W	15000W	1800W	18000W	2000W	20000W	2400W	24000W	
Resolution	24mW	240mW	28.8mW	288mW	32mW	320mW	38.4mW	384mW	
Accuracy	± 0.2% of (Setting+Range)	± 0.1% of (Setting+Range)	± 0.2% of (Setting+Range)	± 0.1% of (Setting+Range)	± 0.2% of (Setting+Range)	± 0.1% of (Setting+Range)	± 0.2% of (Setting+Range)	± 0.1% of (Setting+Range)	
Constant Voltage Mode + Constant Current Mode									
Range	600V	1050A	600V	1260A	600V	1400A	600V	1680A	
Resolution	10mV	16.8mA	10mV	20.16mA	10mV	22.4mA	10mV	26.88mA	
Accuracy	± 1.0% of (Setting + Range)								
Constant Voltage Mode + Constant Power Mode									
Range	600V	15000W	600V	18000W	600V	20000W	600V	24000W	
Resolution	10mV	240mW	10mV	288mW	10mV	320mW	10mV	384mW	
Accuracy	± 1.0% of (Setting + Range)								
Surge Test									
Surge & Normal current	0~1050A		0~1260A		0~1400A		0~1680A		
Surge time	10~1000ms		10~1000ms		10~1000ms		10~1000ms		
Surge step	1~5								
MPPT Mode									
Algorithm	P&O								
Load mode	CV								
P&O interval	1000ms~60000ms ; resolution 1000ms								
Dynamic Mode									
Timing									
Thigh & Tlow	0.010~9.999 / 99.99 / 999.9 / 9999mS								
Resolution	0.001 / 0.01 / 0.1 / 1ms								
Accuracy	1μs / 10μs / 100μs / 1ms + 50ppm								
Slew Rate	0.0432A~2.7A/μs	0.432A~27A/μs	0.048A~3A/μs	0.48A~30A/μs	0.0528A~3.3A/μs	0.528A~33A/μs	0.0576A~3.6A/μs	0.576A~36A/μs	
Resolution	0.0108A/μs	0.108A/μs	0.012A/μs	0.12A/μs	0.0132A/μs	0.132A/μs	0.0144A/μs	0.144A/μs	
Current									
Range	0~105A	105~1050A	0~126A	126~1260A	0~140A	140~1400A	0~168A	168~1680A	
Resolution	1.68mA	16.8mA	2.016mA	20.16mA	2.24mA	22.4mA	2.688mA	26.88mA	
Measurement									
Voltage Read Back									
Range (5 Digital)	0~60V	60~600V	0~60V	60~600V	0~60V	60~600V	0~60V	60~600V	
Resolution	1mV	10mV	1mV	10mV	1mV	10mV	1mV	10mV	
Accuracy	±0.025% of (Reading + Range)								
Current Read Back									
Range (5 Digital)	0~105A	105~1050A	0~126A	126~1260A	0~140A	140~1400A	0~168A	168~1680A	
Resolution	1.68mA	16.8mA	2.016mA	20.16mA	2.24mA	22.4mA	2.688mA	26.88mA	
Accuracy	± 0.05% of (Reading + Range)								
Power Read Back									
Range (5 Digital)	15000W		18000W		20000W		24000W		
Accuracy	± 0.06% of (Reading + Range)								
General									
Typical Short Resistance	0.0096Ω		0.0080Ω		0.0072Ω		0.0060Ω		
Maximum Short Current	1050A		1260A		1400A		1680A		
Load ON Voltage	0.4 ~ 100V								
Load OFF Voltage	0 ~ 100V								
Power Consumption	1100VA		1100VA		1450VA		1450VA		
Dimension (HxWxD)	761x444x763mm		761x444x763mm		887x444x763mm		887x444x763mm		
HxWxD (Not included wheels)	657x444x763mm		657x444x763mm		783x444x763mm		783x444x763mm		
Weight	116.5 kg		124 kg		140.5 kg		155 kg		
Temperature ^{*4}	0~40°C								
Safety & EMC	CE								

Cooling : Advanced Fan Cooled

Input AC Power : 100~240 Vac ±10% , 50/60Hz

Note *1 : The power rating specifications at ambient temperature = 25°C

Note *2 : The range is automatically or forcing to range II only in CC Mode

Note *3 : If the operating current is below range 0.1%, the accuracy specification is 0.1% F.S.

Note *4 : Operating temperature range is 0~40°C , all specifications apply for 25°C±5

ORDER INFORMATION

Options: ① Hook ring ② Rack Mount Kit for Rack



x4



③ Handles

④ Remove wheels



PEL-5015C-600-1050

PEL-5018C-600-1260

PEL-5020C-600-1400

PEL-5024C-600-1680



600V , 1050A , 15KW



600V , 1260A , 18KW



600V , 1400A , 20KW



600V , 1680A , 24KW

Optional Interface: 1. GPIB Card 2. RS-232 Card 3. USB Card 4. LAN Card

Compact High Power DC Electronic Load

Power Curve

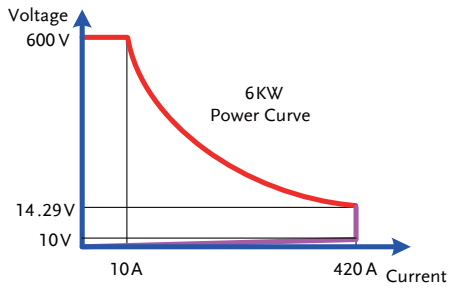

PEL-5006C-600-420

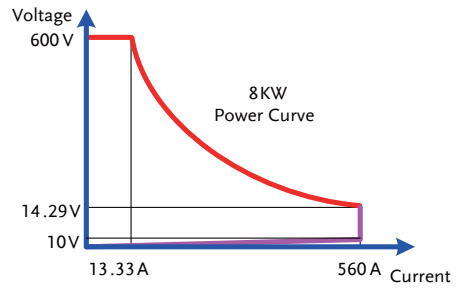

PEL-5008C-600-560

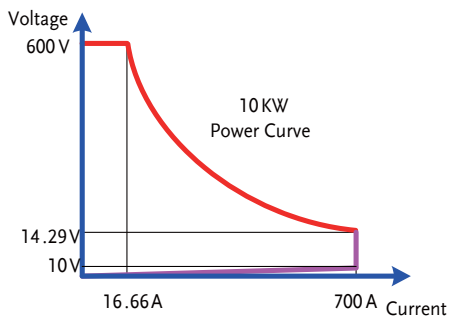

PEL-5010C-600-700

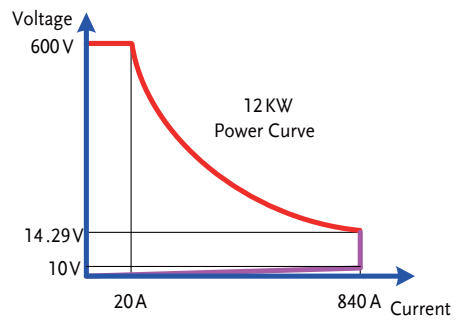

PEL-5012C-600-840

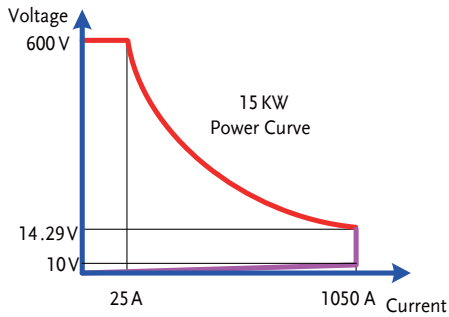

PEL-5015C-600-1050

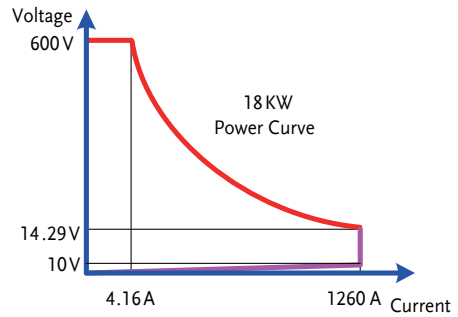

PEL-5018C-600-1260

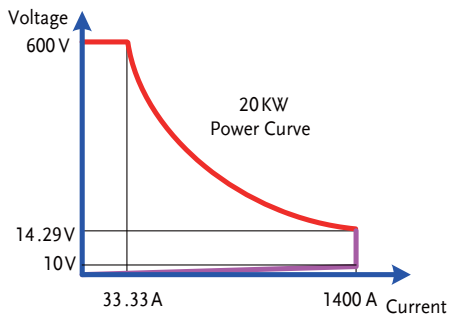

PEL-5020C-600-1400

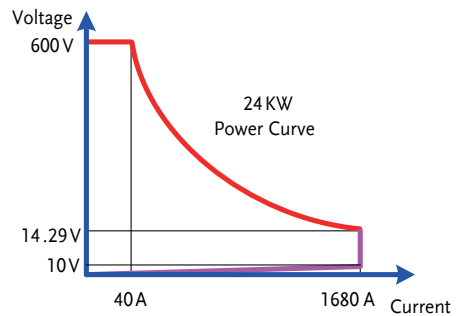

PEL-5024C-600-1680

Compact High Power DC Electronic Load

SPECIFICATIONS								
MODEL	PEL-5006C-1200-240	PEL-5008C-1200-320	PEL-5010C-1200-400	PEL-5012C-1200-480				
Power*1	6KW		8KW		10KW		12KW	
Current	0 ~ 24A	0 ~ 240A	0 ~ 32A	0 ~ 320A	0 ~ 40A	0 ~ 400A	0 ~ 48A	0 ~ 480A
Voltage	0 ~ 1200V							
Min. Operating Voltage	15V @ 240A		15V @ 320A		15V @ 400A		15V @ 480A	
Protections								
Over Power Protection (OPP)	105%							
Over Current Protection (OCP)	104%							
Over Voltage Protection (OVP)	104%							
Over Temp Protection (OTP)	90°C±5							
Constant Current Mode								
Range*2	24A	240A	32A	320A	40A	400A	48A	480A
Resolution	0.384mA	3.84mA	0.512mA	5.12mA	0.64mA	6.4mA	0.768mA	7.68mA
Accuracy*3	± 0.05% of (Setting + Range)							
Constant Resistance Mode								
Range	30KΩ~5Ω	5Ω~0.0625Ω	22.5KΩ~3.75Ω	3.75Ω~0.0468Ω	18KΩ~3Ω	3Ω~0.0375Ω	15KΩ~2.5Ω	2.5Ω~0.0312Ω
Resolution	3.333μS	83.334μΩ	4.444μS	62.5μΩ	5.555μS	50μΩ	6.666μS	41.667μΩ
Accuracy	±0.2% of (Setting + Range)							
Constant Voltage Mode								
Range	1200V							
Resolution	20mV							
Accuracy	± 0.05% of (Setting + Range)							
Constant Power Mode								
Range	600W	6000W	800W	8000W	1000W	10000W	1200W	12000W
Resolution	9.6mW	96mW	12.8mW	128mW	16mW	160mW	19.2mW	192mW
Accuracy	± 0.1% of (Setting+Range)	± 0.1% of (Setting+Range)	± 0.1% of (Setting+Range)	± 0.1% of (Setting+Range)	± 0.1% of (Setting+Range)	± 0.1% of (Setting+Range)	± 0.1% of (Setting+Range)	± 0.1% of (Setting+Range)
Constant Voltage Mode + Constant Current Mode								
Range	1200V	240A	1200V	320A	1200V	400A	1200V	480A
Resolution	20mV	3.84mA	20mV	5.12mA	20mV	6.4mA	20mV	7.68mA
Accuracy	± 1.0% of (Setting + Range)							
Constant Voltage Mode + Constant Power Mode								
Range	1200V	6000W	1200V	8000W	1200V	10000W	1200V	12000W
Resolution	20mV	96mW	20mV	128mW	20mV	160mW	20mV	192mW
Accuracy	± 1.0% of (Setting + Range)							
Surge Test								
Surge & Normal current	0~240A		0~320A		0~400A		0~480A	
Surge time	10~1000ms		10~1000ms		10~1000ms		10~1000ms	
Surge step	1~5							
MPPT Mode								
Algorithm	P&O							
Load mode	CV							
P&O interval	1000ms~6000ms ; resolution 1000ms							
Dynamic Mode								
Timing	0.010~9.999 / 99.99 / 999.9 / 9999ms							
Thigh & Tlow	0.010~9.999 / 99.99 / 999.9 / 9999ms							
Resolution	0.001 / 0.01 / 0.1 / 1ms							
Accuracy	1μs / 10μs / 100μs / 1ms + 50ppm							
Slew Rate	0.0192A~1.2A/μs	0.192A~12A/μs	0.0192A~1.2A/μs	0.192A~12A/μs	0.0224A~1.4A/μs	0.224A~14A/μs	0.0256A~1.6A/μs	0.256A~16A/μs
Resolution	0.0048A/μs	0.048A/μs	0.0048A/μs	0.048A/μs	0.0056A/μs	0.056A/μs	0.0064A/μs	0.064A/μs
Current								
Range	0~24A	24~240A	0~32A	32~320A	0~40A	40~400A	0~48A	48~480A
Resolution	0.384mA	3.84mA	0.512mA	5.12mA	0.64mA	6.4mA	0.768mA	7.68mA
Measurement								
Voltage Read Back								
Range (5 Digital)	0~120V	120~1200V	0~120V	120~1200V	0~120V	120~1200V	0~120V	120~1200V
Resolution	2mV	20mV	2mV	20mV	2mV	20mV	2mV	20mV
Accuracy	±0.025% of (Reading + Range)							
Current Read Back								
Range (5 Digital)	0~24A	24~240A	0~32A	32~320A	0~40A	40~400A	0~48A	48~480A
Resolution	0.384mA	3.84mA	0.512mA	5.12mA	0.64mA	6.4mA	0.768mA	7.68mA
Accuracy	±0.05% of (Reading + Range)							
Power Read Back								
Range (5 Digital)	6000W		8000W		10000W		12000W	
Accuracy	± 0.06% of (Reading + Range)							
General								
Typical Short Resistance	0.0625Ω		0.0469Ω		0.0375Ω		0.0313Ω	
Maximum Short Current	240A		320A		400A		480A	
Load ON Voltage	0.96 ~ 240V							
Load OFF Voltage	0 ~ 240V							
Power Consumption	400VA		750VA		750VA		750VA	
Dimension (HxWxD)	446x444x763mm		572x444x763mm		572x444x763mm		572x444x763mm	
HxWxD (Not included wheels)	342x444x763mm		468x444x763mm		468x444x763mm		468x444x763mm	
Weight	62 kg		77.5 kg		84.8 kg		92 kg	
Temperature*4	0~40°C							
Safety & EMC	CE							

Cooling : Advanced Fan Cooled

Input AC Power : 100~240 Vac ±10% , 50/60Hz

Note *1 : The power rating specifications at ambient temperature = 25 °C

Note *2 : The range is automatically or forcing to range II only in CC Mode

Note *3 : If the operating current is below range 0.1%, the accuracy specification is 0.1% F.S.

Note *4 : Operating temperature range is 0~40 °C , all specifications apply for 25 °C±5 °C

ORDER INFORMATION

Options: ① Hook ring ② Rack Mount Kit for Rack



x4



③ Handles ④ Remove wheels



PEL-5006C-1200-240 PEL-5008C-1200-320 PEL-5010C-1200-400 PEL-5012C-1200-480



1200V , 240A , 6KW



1200V , 320A , 8KW



1200V , 400A , 10KW



1200V , 480A , 12KW

Optional Interface: 1. GPIB Card 2. RS-232 Card 3. USB Card 4. LAN Card

Compact High Power DC Electronic Load

SPECIFICATIONS								
MODEL	PEL-5015C-1200-600	PEL-5018C-1200-720	PEL-5020C-1200-800	PEL-5024C-1200-960				
Power*1	15KW		18KW		20KW		24KW	
Current	0 ~ 60A	0 ~ 600A	0 ~ 72A	0 ~ 720A	0 ~ 80A	0 ~ 800A	0 ~ 96A	0 ~ 960A
Voltage	0 ~ 1200V							
Min. Operating Voltage	15V @ 600A		15V @ 720A		15V @ 800A		15V @ 960A	
Protections								
Over Power Protection (OPP)	105%							
Over Current Protection (OCP)	104%							
Over Voltage Protection (OVP)	104%							
Over Temp Protection (OTP)	90°C±5°C							
Constant Current Mode								
Range*2	60A	600A	72A	720A	80A	800A	96A	960A
Resolution	0.96mA	9.6mA	1.152mA	11.52mA	1.28mA	12.8mA	1.536mA	15.36mA
Accuracy*3	± 0.05% of (Setting + Range)							
Constant Resistance Mode								
Range	12Ω~2Ω	2Ω~0.0250Ω	10KΩ~1.666Ω	1.666Ω~0.0208Ω	9KΩ~1.5Ω	1.5Ω~0.0187Ω	7.5KΩ~1.25Ω	1.25Ω~0.0156Ω
Resolution	8.3333μS	33.334μΩ	10μS	27.778μΩ	11.111μS	25μΩ	13.333μS	20.834μΩ
Accuracy	±0.2% of (Setting + Range)							
Constant Voltage Mode								
Range	1200V							
Resolution	20mV							
Accuracy	± 0.05% of (Setting + Range)							
Constant Power Mode								
Range	1500W	15000W	1800W	18000W	2000W	20000W	2400W	24000W
Resolution	24mW	240mW	28.8mW	288mW	32mW	320mW	38.4mW	384mW
Accuracy	± 0.1% of (Setting+Range)	± 0.1% of (Setting+Range)	± 0.1% of (Setting+Range)	± 0.1% of (Setting+Range)	± 0.1% of (Setting+Range)	± 0.1% of (Setting+Range)	± 0.1% of (Setting+Range)	± 0.1% of (Setting+Range)
Constant Voltage Mode + Constant Current Mode								
Range	1200V	600A	1200V	720A	1200V	800A	1200V	960A
Resolution	20mV	9.6mA	20mV	3.2mA	20mV	3.84mA	20mV	15.36mA
Accuracy	± 1.0% of (Setting + Range)							
Constant Voltage Mode + Constant Power Mode								
Range	1200V	15000W	1200V	18000W	1200V	20000W	1200V	24000W
Resolution	20mV	240mW	20mV	288mW	20mV	320mW	20mV	384mW
Accuracy	± 1.0% of (Setting + Range)							
Surge Test								
Surge & Normal current	0~600A		0~720A		0~800A		0~960A	
Surge time	10~1000ms		10~1000ms		10~1000ms		10~1000ms	
Surge step	1~5							
MPPT Mode								
Algorithm	P&O							
Load mode	CV							
P&O interval	1000ms~6000ms ; resolution 1000ms							
Dynamic Mode								
Timing								
Thigh & Tlow	0.010~9.999 / 99.99 / 999.9 / 9999mS							
Resolution	0.001 / 0.01 / 0.1 / 1ms							
Accuracy	1μs / 10μs / 100μs / 1ms + 50ppm							
Slew Rate	0.0288A~1.8A/μs	0.288A~18A/μs	0.032A~2A/μs	0.32A~20A/μs	0.0352A~2.2A/μs	0.352A~22A/μs	0.0384A~2.4A/μs	0.384A~24A/μs
Resolution	0.0072A/μs	0.072A/μs	0.008A/μs	0.08A/μs	0.0088A/μs	0.088A/μs	0.0096A/μs	0.096A/μs
Current								
Range	0~60A	60~600A	0~72A	72~720A	0~80A	80~800A	0~96A	96~960A
Resolution	0.96mA	9.6mA	1.152mA	11.52mA	1.28mA	12.8mA	1.536mA	15.36mA
Measurement								
Voltage Read Back								
Range (5 Digital)	0~120V	120~1200V	0~120V	120~1200V	0~120V	120~1200V	0~120V	120~1200V
Resolution	2mV	20mV	2mV	20mV	2mV	20mV	2mV	20mV
Accuracy	±0.025% of (Reading + Range)							
Current Read Back								
Range (5 Digital)	0~60A	60~600A	0~72A	72~720A	0~80A	80~800A	0~96A	96~960A
Resolution	0.96mA	9.6mA	1.152mA	11.52mA	1.28mA	12.8mA	1.536mA	15.36mA
Accuracy	±0.05% of (Reading + Range)							
Power Read Back								
Range (5 Digital)	15000W		18000W		20000W		24000W	
Accuracy	± 0.06% of (Reading + Range)							
General								
Typical Short Resistance	0.0250Ω		0.0209Ω		0.0188Ω		0.0157Ω	
Maximum Short Current	600A		720A		800A		960A	
Load ON Voltage	0.96 ~ 240V							
Load OFF Voltage	0 ~ 240V							
Power Consumption	1100VA		1100VA		1450VA		1450VA	
Dimension (HxWxD)	761x444x763mm		761x444x763mm		887x444x763mm		887x444x763mm	
HxWxD (Not included wheels)	657x444x763mm		657x444x763mm		783x444x763mm		783x444x763mm	
Weight	116.5 kg		124 kg		140.5 kg		155 kg	
Temperature*4	0~40°C							
Safety & EMC	CE							

Cooling : Advanced Fan Cooled

Input AC Power : 100~240 Vac ±10% · 50/60Hz

Note *1 : The power rating specifications at ambient temperature = 25°C

Note *2 : The range is automatically or forcing to range II only in CC Mode

Note *3 : If the operating current is below range 0.1%, the accuracy specification is 0.1% F.S.

Note *4 : Operating temperature range is 0~40°C · all specifications apply for 25°C±5°C

ORDER INFORMATION

PEL-5015C-1200-600

PEL-5018C-1200-720

PEL-5020C-1200-800

PEL-5024C-1200-960

Options: ① Hook ring ② Rack Mount Kit for Rack



Optional Interface: 1. GPIB Card 2. RS-232 Card 3. USB Card 4. LAN Card

Compact High Power DC Electronic Load

Power Curve

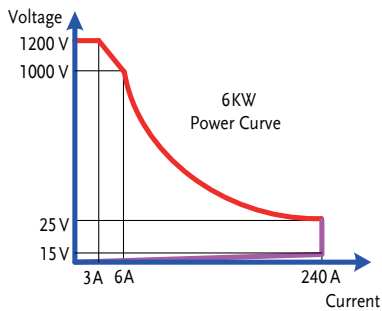
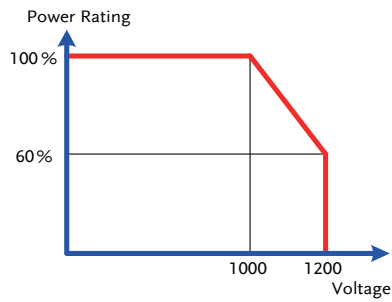

PEL-5006C-1200-240

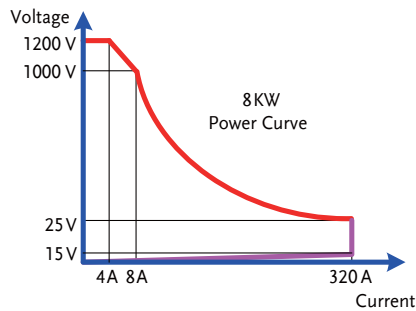

PEL-5008C-1200-320

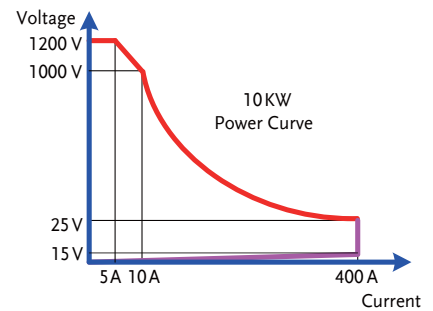

PEL-5010C-1200-400

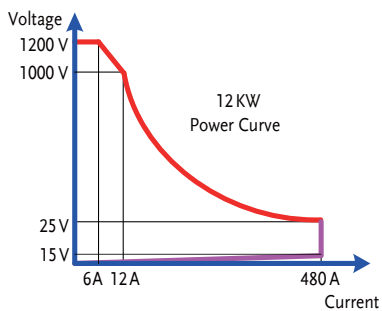

PEL-5012C-1200-480

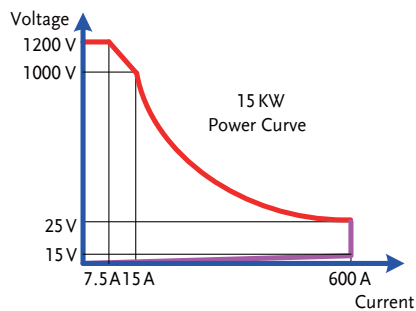

PEL-5015C-1200-600

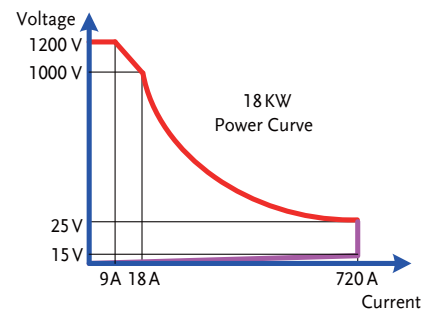

PEL-5018C-1200-720

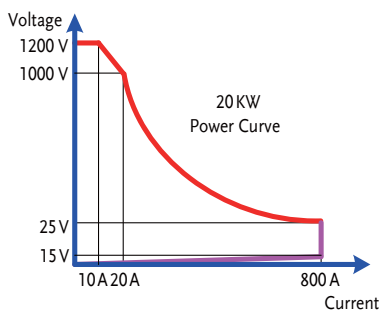

PEL-5020C-1200-800

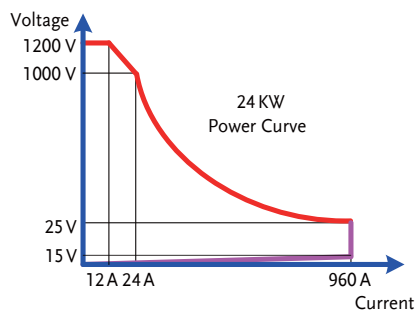

PEL-5024C-1200-960

PEL-5000C Series EXTERNAL DIMENSIONS

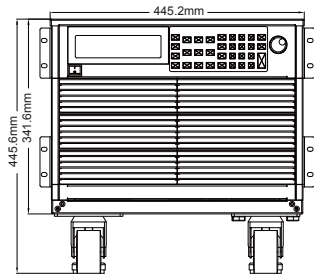

6kW

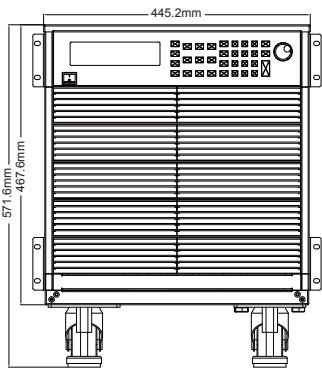
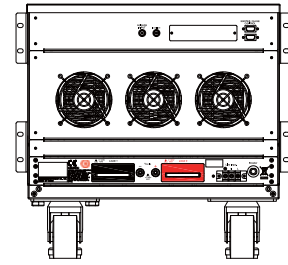
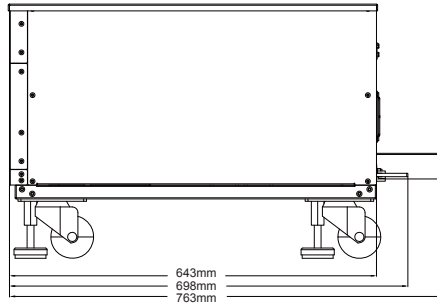

8kW/10kW/12kW

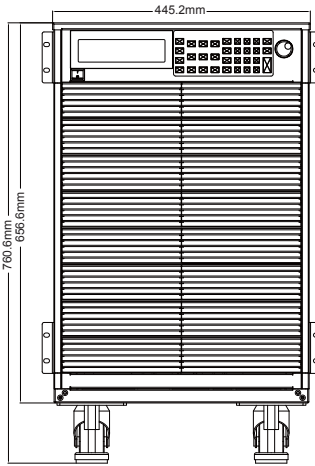

15kW/18kW

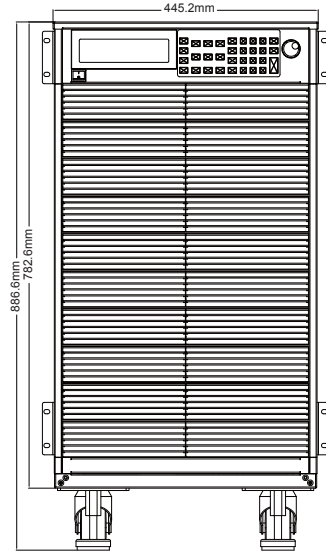

20kW/24kW

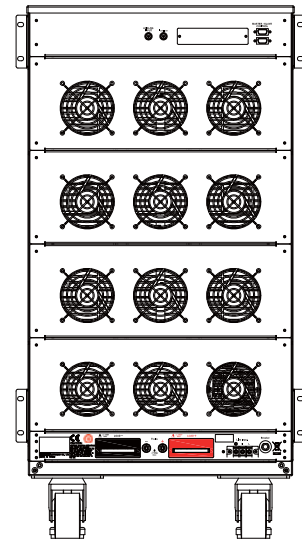
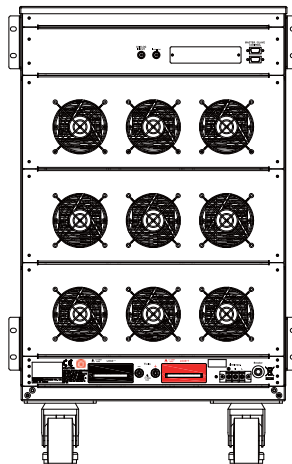
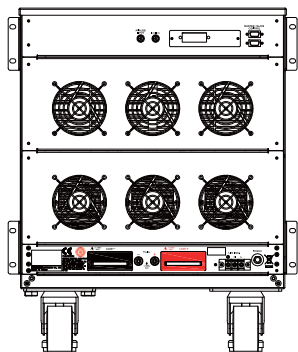

OPTIONAL ACCESSORIES

- PEL-022 GPIB Card
- PEL-023 RS-232 Card
- PEL-024 LAN Card
- PEL-025 USB Card

- PEL-026 Hook Ring
- PEL-027 Rack Mount Kit
- PEL-028 Handles

Global Headquarters
GOOD WILL INSTRUMENT CO., LTD.
 T +886-2-2268-0389 F +886-2-2268-0639

China Subsidiary
GOOD WILL INSTRUMENT (SUZHOU) CO., LTD.
 T +86-512-6661-7177 F +86-512-6661-7277

Malaysia Subsidiary
GOOD WILL INSTRUMENT (SEA) SDN. BHD.
 T +604-6111122 F +604-6115225

Europe Subsidiary
GOOD WILL INSTRUMENT EURO B.V.
 T +31(0)40-2557790 F +31(0)40-2541194

U.S.A. Subsidiary
INSTEK AMERICA CORP.
 T +1-909-399-3535 F +1-909-399-0819

Japan Subsidiary
TEXIO TECHNOLOGY CORPORATION.
 T +81-45-620-2305 F +81-45-534-7181

Korea Subsidiary
GOOD WILL INSTRUMENT KOREA CO., LTD.
 T +82-2-3439-2205 F +82-2-3439-2207

India Subsidiary
GW INSTEK INDIA LLP.
 T +91-80-6811-0600 F +91-80-6811-0626

GW INSTEK
 Simply Reliable



Website



Facebook



LinkedIn